

Nasal Septal Perforation Prosthesis

Blom-Singer®

The voice of experience since 1978

The new solution for non-surgical closure

2-piece magnetically coupled prosthesis

A study¹ of patients using a 2-piece magnetically coupled prosthesis showed:

- *No particular discomfort on insertion, removal, or replacement*
- *Easier debris removal for ENTs*

Choice of shape, size, and thickness for a comfortable fit

Two medical-grade, silicone-covered neodymium magnets couple securely.

Multiple options – round or oval, 6 sizes each – help ensure an accurate fit:

- *Less pistoning*
- *Less side-to-side movement*

Reduce or eliminate symptoms:

- *Bleeding, crusting*
- *Breathing difficulty, nasal pressure, whistling*
- *Rhinorrhea, epistaxis, infection*



INHEALTH
TECHNOLOGIES®

Nasal Septal Perforation Prosthesis

The new solution for non-surgical closure

Blom-Singer®

The voice of experience since 1978

OVAL

11 x 13 mm

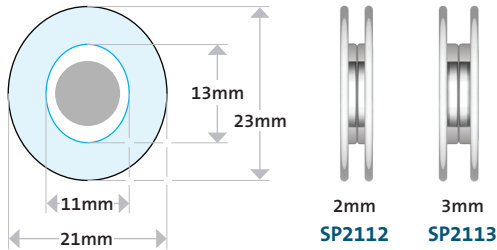

13 x 17 mm

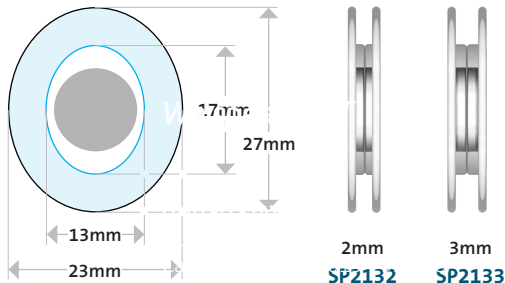

15 x 21 mm

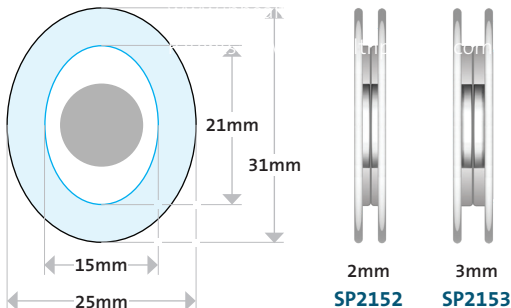

ROUND

5 mm

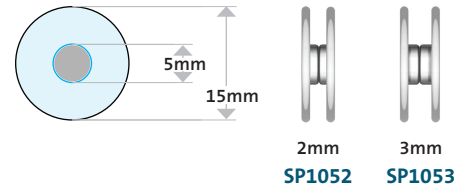

7 mm

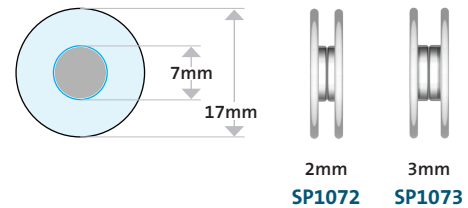

10 mm

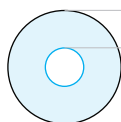
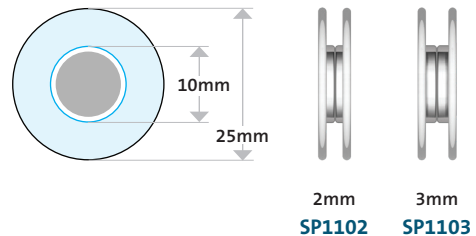

Flange width is 5mm for all prostheses.

Diagrams actual size

INHEALTH
TECHNOLOGIES®

UNITED STATES
1110 Mark Avenue
Carpinteria, CA 93013-2918 USA
Toll Free: 800.477.5969
Toll Free Fax: 888.371.1530

ORDER ONLINE
www.inhealth.com

Patents: www.inhealthpatents.com

1. Teschner M, et al. *Eur Arch Otorhinolaryngol.* 2012 Mar;269(3):861-5.

The Blom-Singer Nasal Septal Perforation Prosthesis was designed by Eric D. Blom, Ph.D., co-inventor of the breakthrough in voice restoration: the Blom-Singer Voice Prosthesis.

©2017 InHealth Technologies — Manufactured by Freudenberg Medical, LLC (161011)